

# JCB

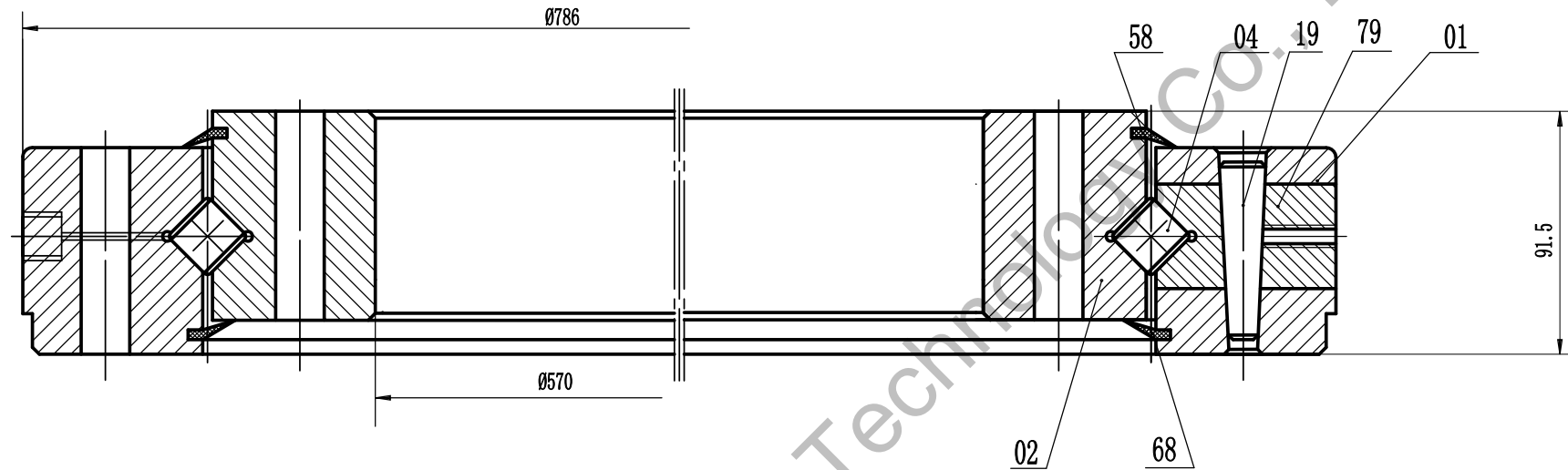

**Remark:**

1. Luoyang JCB Bearing Technology Co., Ltd is a technical Inc, specialize in designing and manufacturing slewing ring bearing, we can design and manufactur all kinds of slewing bearing according to client's requirement.
2. This drawing is reference for user,if you need formal drawing,please contact wth us sales@jcb-bearing.com, the official drawing will be submitted after order confirmation.

**Contact information**

Company Address : No.3 Lianmeng road, Luoyang, Henan, China.  
Postal code : 471003  
Phone : 86-379-68611678 Fax : 86-379-68611679  
E-mail: sales@jcb-bearing.com  
Reserved E-mail: sales@slewing-ring-bearings.com  
Website: www.jcb-bearing.com  
www.slewing-ring-bearings.com



Crossed roller slewing rings	90-1Z30-0678-1037		
	weight (lbs)		
		120	
Luoyang JCB Bearing Technology Co., Ltd			